



# User Guide



Congratulations on  
purchasing a genuine

# ZIPSCREEN®



SUN & WIND  
PROTECTION



INSECT  
PROTECTION



ALL SEASONS  
LIVING



DESIGN  
INNOVATION



EASY TO  
CONTROL

## Contents

---

	Page
Operation Instructions	
Pre-operation Instructions .....	1
Spring Control .....	1
Crank Gear Control .....	2
AUTOMATE Motorized Control .....	3
Smart HOME CONTROL .....	5
Safety and Support	
Safety & correct procedure .....	7
Maintaining your zipscreen .....	7
Warranty and support .....	8

**Warning** | Please review this document prior to operating your zipscreen.

## Pre-Operation

During the transportation process, the fabric used for your Zipscreen™ tends to be tightly wrapped in order to keep it protected. This can cause an unwanted rippling or wrinkling effect after it is installed.

To ensure rippling is ironed out, it is best to leave your Zipscreen shades down for one to two days in clear weather, until the fabric is fully settled.

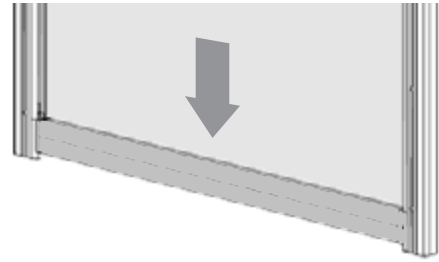

## Spring control

All Zipscreen systems are built to operate smoothly and effortlessly. If it is proving to be difficult to lower or raise your shade, through no fault of your own, please contact your Zipscreen retailer.

### Lower your shades

Grip the center of the weight bar and guide the shade downwards, gently. Operation from the center is crucial to evenly distribute force and ensure a smooth gliding shade. Always handle your Zipscreen from the center of the weight bar.

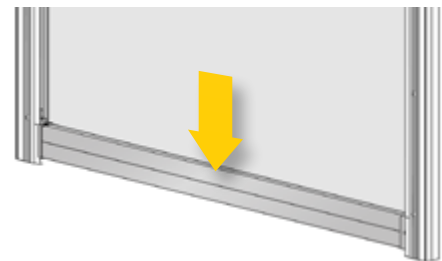

#### ► Systems with Ultra-lock:

Pull the shade downwards until you hear one click. This indicates your shade is now locked. If you hear two clicks, the shade has travelled too low and has unlocked. If so, raise the weight bar and lower it back down to the first click.

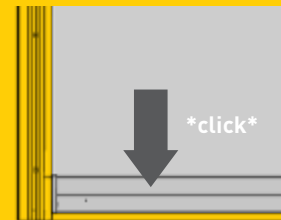

### Raise your shades

Grip the center of the weight bar and guide the shade upwards, gently. Operation from the center is crucial to evenly distribute force and ensure a smooth gliding shade. Always handle your Zipscreen from the center of the weight bar. If your shade rolls up unevenly, bring the shade down and then begin to raise it again, ensuring both sides of the shade are moving smoothly and evenly.

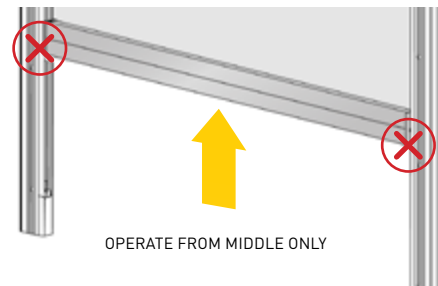

#### ► Systems with Ultra-lock:

Pull the shade downwards until you hear one click. This indicates your shade is now unlocked. Once unlocked, lift the weight bar upwards to raise the shade.

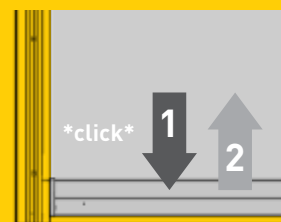

### Desired height

Zipscreen outdoor blinds can be left at any desired height. Simply lower or raise the shade to the desired level and the shade will rest in the position set. To ensure longevity, never forcefully operate your outdoor shade system. If you experience irregular jarring, refer to the 'correct procedure' section of this user guide or see your retailer.

# Crank Gear Control

All Zipscreen systems are built to operate smoothly and effortlessly. If it is proving to be difficult to lower or raise your shade, through no fault of your own, please contact your Zipscreen retailer.

## Attach and Detach Crank Gear Handle

Hold the crank gear arm steadily and guide the tip of the arm to the end of the coupling joint at the top of the Zipscreen. Firmly push the arm into the coupling joint until it securely clicks into place. To detach the arm, simply pull the arm downwards, away from the coupling joint. The arm will click and dislodge from the coupling joint. Store the arm in a safe place until it needs to be used again.

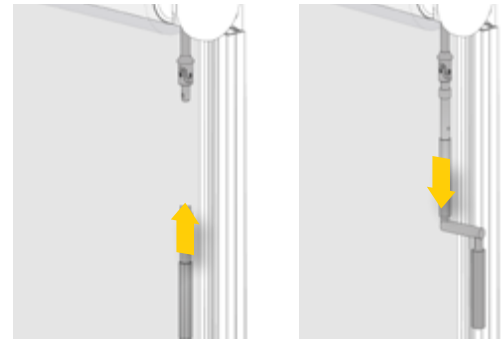

## Crank Arm Support

If a crank arm support is in use, unfold the arm and ensure the entire arm is straight. Firmly push the crank arm into the support clip to secure it in place. When the crank arm needs to be used, simply pull the arm away from the support to dislodge it from the grip of the support.

## Lower your shades

Ensure the crank arm is connected to the joining arm at the top of the Zipscreen and is folded in an 'L' formation. Hold the top grip of the crank arm in one hand and the bottom grip in the other, then rotate the arm counterclockwise to lower the shade.



### ► Systems with Ultra-lock:

Allow the shade to move downwards until you hear one click. This indicates your shade is now locked. If you hear two clicks, then the shade has travelled too low and has unlocked. If so, crank the arm in a clockwise direction to raise the shades and then lower it back down until you hear the first click. Once locked, crank the arm clockwise to tension your system's fabric.

## Raise your shades

Ensure the crank arm is connected to the joining arm at the top of the Zipscreen and is folded in an 'L' formation. Hold the top grip of the crank arm in one hand and the bottom grip in the other, then rotate the arm clockwise to raise the shade.



### ► Systems with Ultra-lock:

Allow the shade to move downwards until you hear a click. This indicates your shade is now unlocked. Once unlocked, crank the arm in a clockwise direction to raise the shades.

## Desired height

Simply lower or raise the shade to the desired level and the shade will rest in the position set. To ensure longevity, never forcefully operate the system. If you experience irregular jarring, refer to the 'support' section of this user guide or see your retailer if smooth operation is persistently unachieved.

# Automate Motorized Control

## Automate Remote

Your Automate remote should be pre-programmed by your installer with set channels for each one of your Zipscreen outdoor shades. Always keep your remote well-protected and stored away from children, extreme temperatures and liquid.

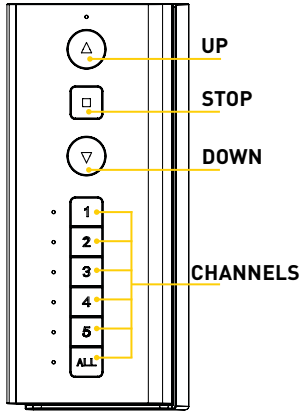

### Push5 Remote Control

Channels allow the user to select which Zipscreen shade you would like to control, if multiple systems are installed within the same vicinity. Every channel is pre-programmed to control a designated shade/s. To switch between channels, tap the channel number you desire until a blue illuminated light appears next to the number. You can also group channels together by subsequently pressing a combination of numbers until they are illuminated. Alternatively, you can control all your shades simultaneously by pushing the 'All' button.

## Push15 Remote Control

Channels allow the user to select which Zipscreen shade they'd like to control if multiple systems are installed within the same vicinity. Channel '0' allows you to take control of all Zipscreen shades simultaneous, each channel above '0' is pre-programmed to control a designated shade. To go up one channel at a time, press the '+' button on the remote. Alternatively, to go down through the channels, press the '-' button, until you find your desired channel. For details on which channels correspond to each of your Zipscreen shades, please contact your installer. To move your Zipscreen shades press the 'UP' or 'DOWN' buttons or use the levelling bar on the screen.

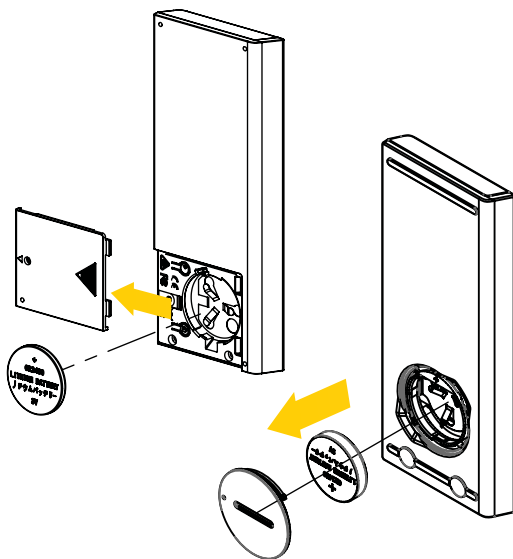
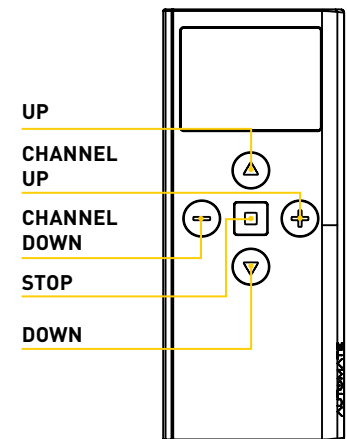

### Battery Replacement

If your remote does not seem to be registering commands, please ensure it has adequate power, your Automate remote utilizes a small 3V CR2450 battery. To replace the battery, find the battery cover situated on the bottom half of the back of the remote, and slide it off/twist the battery cover off with the coin tool provided in the cradle. When finished, simply replace the cover back on and turn to the locked position.

If you believe your remote is not functioning as described, through no fault of your own, please contact your retailer for further details on troubleshooting or resolving your issues.

## Lower your shades

On your Automate remote, find and press the 'down' button, once. This will initiate the movement of the shade, and it will begin to lower. The system will stop in its pre-programmed position, at the bottom of the side guide.

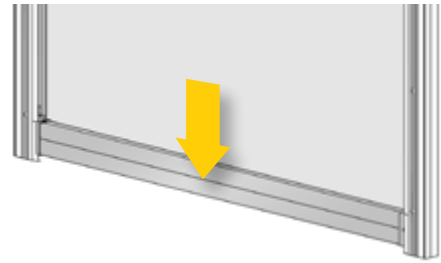

### ► Systems with Ultra-lock:

The shade will automatically move down until a 'click' is heard, indicating the system is locked. No intervention is necessary, your Zipscreen is pre-programmed to lock itself at the end of the movement.

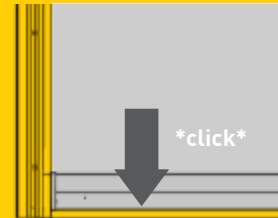

## Raise your shades

On your Automate remote, find and press the 'up' button, once. This will initiate the movement of the shade, and it will begin to raise. The system will stop in its pre-programmed position, at the top of the side guide.

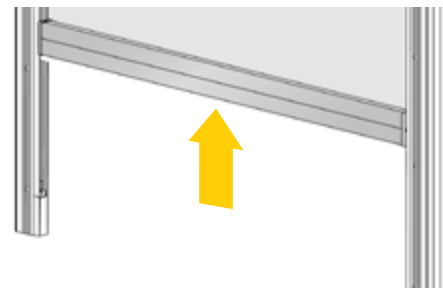

### ► Systems with Ultra-lock:

The shade will automatically move down until a 'click' is heard indicating the system is unlocked. It will then begin to move upwards as directed. No intervention is necessary, your Zipscreen is pre-programmed to unlock itself at the beginning of the movement.

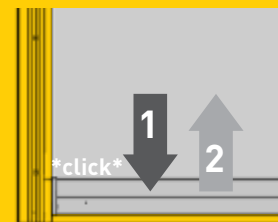

## Desired height

After pressing either the up or down button, wait for your Zipscreen to move to the desired position, then once content with the shade's height, press the 'stop' button to halt movement. The shade will remain secured in the established position.



### Automate Solar Powered ARC Wind & Light Sensor

Your wind sensor is pre-programmed to raise your shade when weather conditions change. The sensor automatically moves your system to prevent damage and optimize the climate of your area. Increased sunshine will trigger the shade to come down, while extreme wind, automatically raises the shade, keeping your system protected. If your system is prematurely being activated by the system, please contact your installer and suggest a reprogramming of your sensor. The Automate Solar Sensor is the perfect addition to any Zipscreen installation, ask your local retailer about how you can get one in your home, today.

# Smart home Control

Pair your motorized Zipscreen with an Automate Pulse Hub to activate smart control.

## Automate App

### Setup

Download the Automate app on your smart device, from either the Apple App store or Android's Google Play store. Once downloaded, create an account and register your email address, then follow the steps to set up your shades.



### Control

The Automate app offers four different points of control and live feedback of your shade's position, so you can easily see what your Zipscreen is doing, even when away from home.

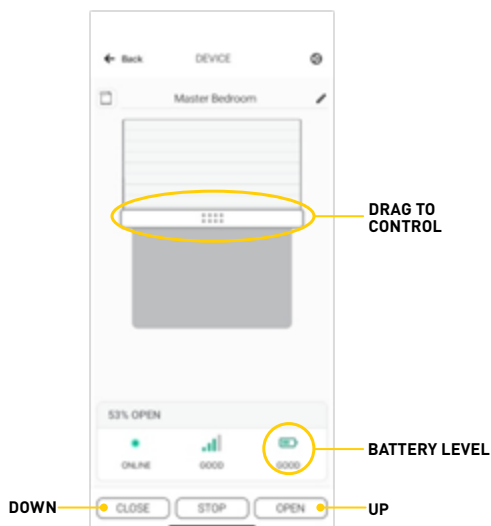

#### Touch and drag

Touch and drag the gold bar either up or down to your desired shade height and then release. This will feed real-time information to your shade and allow it to situate to the position set on screen.

#### Classic control

Raise or lower your shades with the up and down buttons displayed on your device's screen. Either button will initiate an automatic movement of the shade.



# Voice Control

## Setup APPLE HOMEKIT

Open the “HomeKit” app on your Apple device or download it from the Apple App Store. Click the “Add Accessory” button and then simply scan the bottom QR code of your Automate Pulse 2. Follow the prompts on screen until your Pulse Hub is paired. For a more detailed guide see the links listed in the support section.

## Setup Google Home

Download the Google Home app on your smart device, from either the Apple App store or Android’s Google Play store. Once downloaded, create an account and register your email address, then click “Add Accessory” and search for the “Automate Shades” Google Action. Follow the on-screen prompts to finalize the setup. For a more detailed guide see the links listed in the support section.

## Setup Alexa

Open the Alexa app on your smart device or download it from either the Apple App store or Android’s Google Play store. Simply search for “Automate Shades” in Alexa’s skills library, and add the skill to your Alexa. For a more detailed guide see the links listed in the support section.

# Control

**Apple Siri:** Simply exclaim “Hey Siri” to wake your device, and then proceed to instruct Siri whether you’d like to raise your Zipscreen, lower it, or what percentage you’d like to set its position to. Ex. “Hey Siri, raise Zipscreen” or “Hey Siri, set Zipscreen to 35%”.

**Google Home:** Simply exclaim “Ok Google” to wake your device, and then proceed to instruct Google whether you’d like to raise your Zipscreen, lower it, or what percentage you’d like to set its position to. Ex. “Ok Google raise Zipscreen” or “Ok Google, set Zipscreen to 35%”.

**Amazon Alexa:** Simply exclaim “Alexa” to wake your device, and then proceed to instruct Alexa what percentage you’d like to set the shade position to. Ex. “Alexa, set Zipscreen to 35%”.

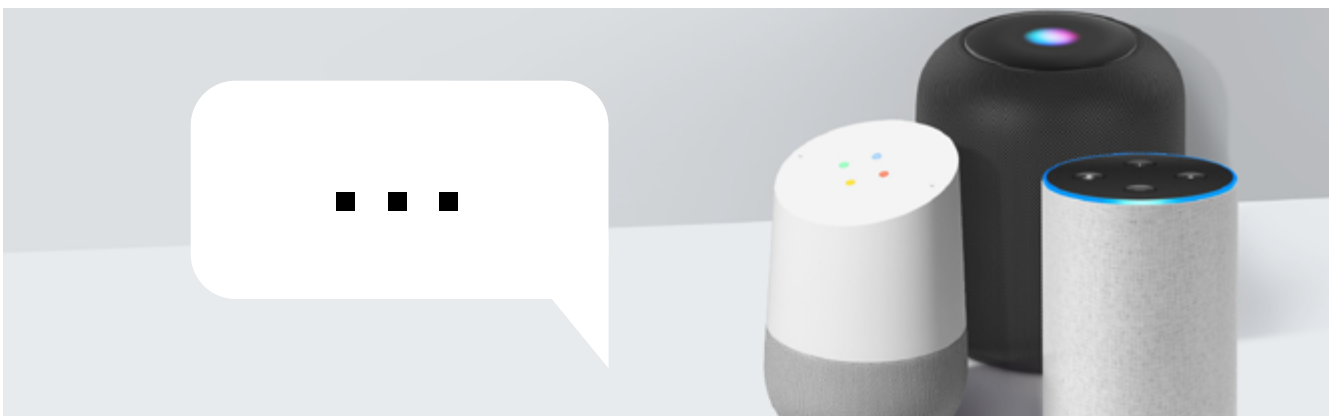

# Cleaning

---

It is recommended to clean your Zipscreen at least every three months, or more frequently for coastal locations to ensure powder coated surfaces are free from dirt, dust and grime.

Always attend to dirt, animal droppings, and stains as soon as possible, to prevent potential deterioration of your system.

Aluminium extrusions can be cleaned with a soft cloth and warm soapy fresh water with a small amount of mild detergent if required.

To maintain fabric cleanliness, please refer to your retailer and find more information about the fabric used by your system. Most external fabrics can be washed with a low pressure hose and soft brush. Always allow the fabric to completely dry before retracting the screen.

In dusty or seafront locations, your Zipscreen may benefit from an application of silicone spray lubricant in the side channels to ensure smooth operation.



Never clean your Zipscreen with abrasive products, chemicals or solvents.



Do not use a pressure hose to clean your Zipscreen.



It is extremely important that oil based lubricants are not used, e.x. WD40, as they will attract dust build-up in the channel.

# Safety & Correct Procedure

---



Do not leave the Zipscreen blind down when you are away from your home or in extreme weather conditions (strong winds above 31 mph).



Do not roll the Zipscreen blind up when wet (to avoid mould and mildew build up). If extreme winds are present (above 31 mph), roll up your Zipscreen and wait for the weather to settle, before attempting to dry your blind again.



Do not force the Zipscreen blind up or down if it is jamming. Forcing the Zipscreen blind may result in further damage (for example, the zip may be forced out of the side guide, or the fabric may rip). Contact your Zipscreen supplier for guidelines of how to fix.



Do not lean persons or objects against the fabric, especially while the system is in motion. Always ensure there are no obstructions while lowering the blind.



Do not operate spring controlled Zipscreen blinds from the sides

# Warranty

---

To discuss warranty information, please contact your retailer. Zipscreen does offer a 5-year warranty to suppliers on the system's hardware. If you have any reason for concern, questions, replacements, claims and servicing, please directly contact your retailer. For further guidance and support, email [Info@zipscreen.com](mailto:Info@zipscreen.com).

# Support

---



Support  
References



Contact a  
Retailer

Your Zipscreen supplier

---

